

应用分子遗传标记探讨 群落水平种群格局形成

中国科学院华南植物园

王峥峰 叶万辉 曹洪麟

一、分子遗传标记

二、分子遗传标记和种群空间格局

三、具体应用（空间遗传结构、花粉流、种子流）

四、鼎湖山大样地开展的研究

五、展望

一、分子遗传标记

分子遗传标记的一个重要功能在于揭示个体间的亲缘关系

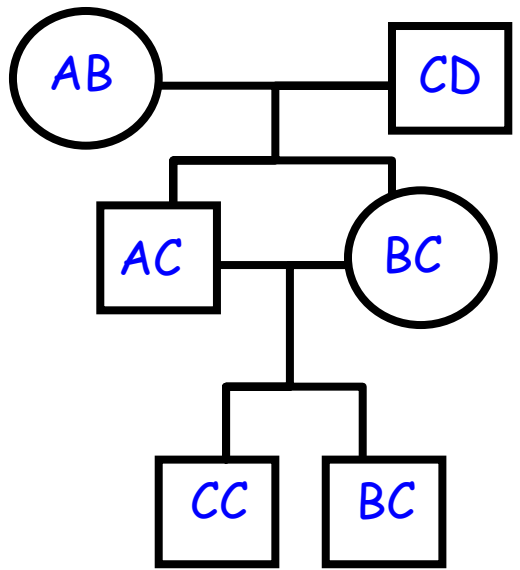
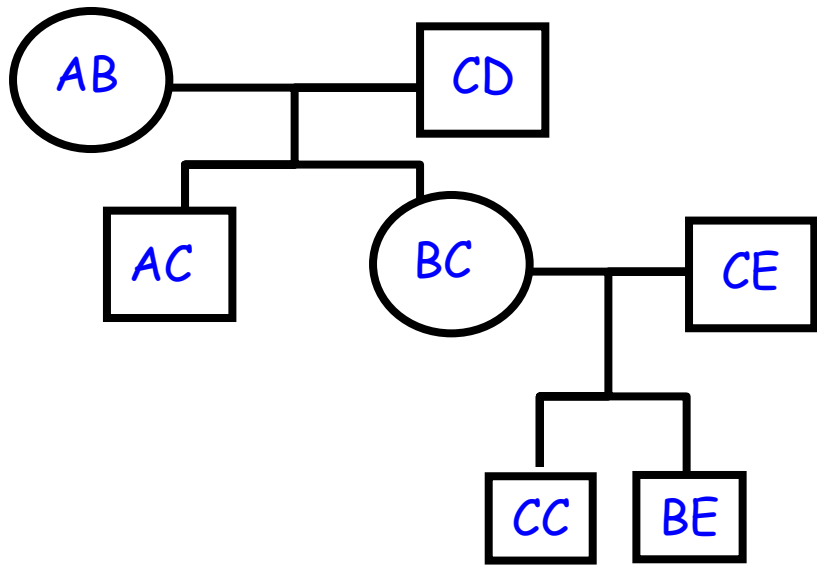

微卫星体 (Microsatellite)



一一对应的关系明确

AFLP

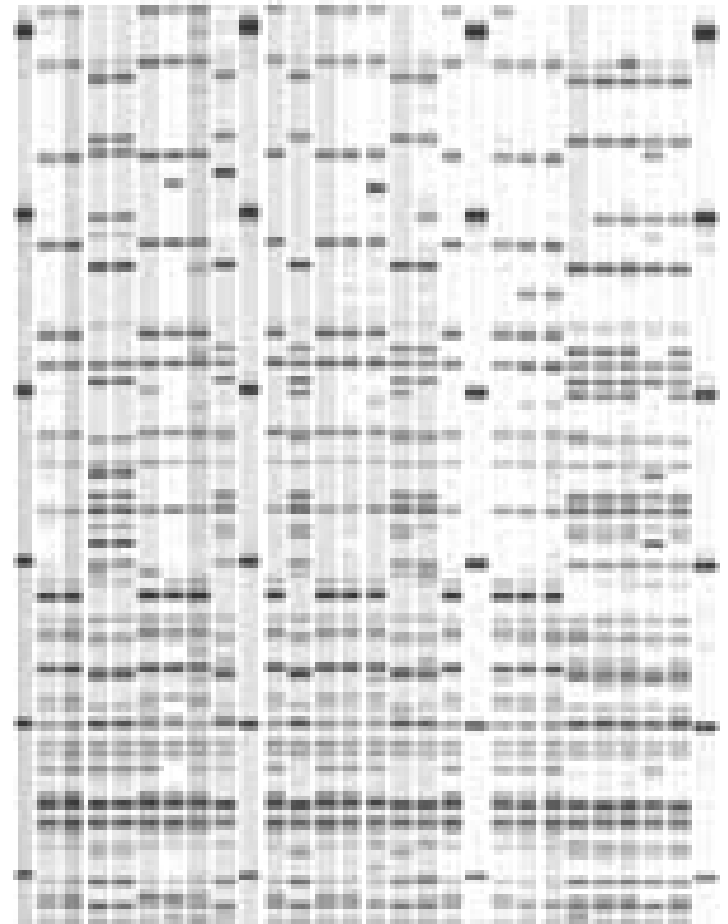

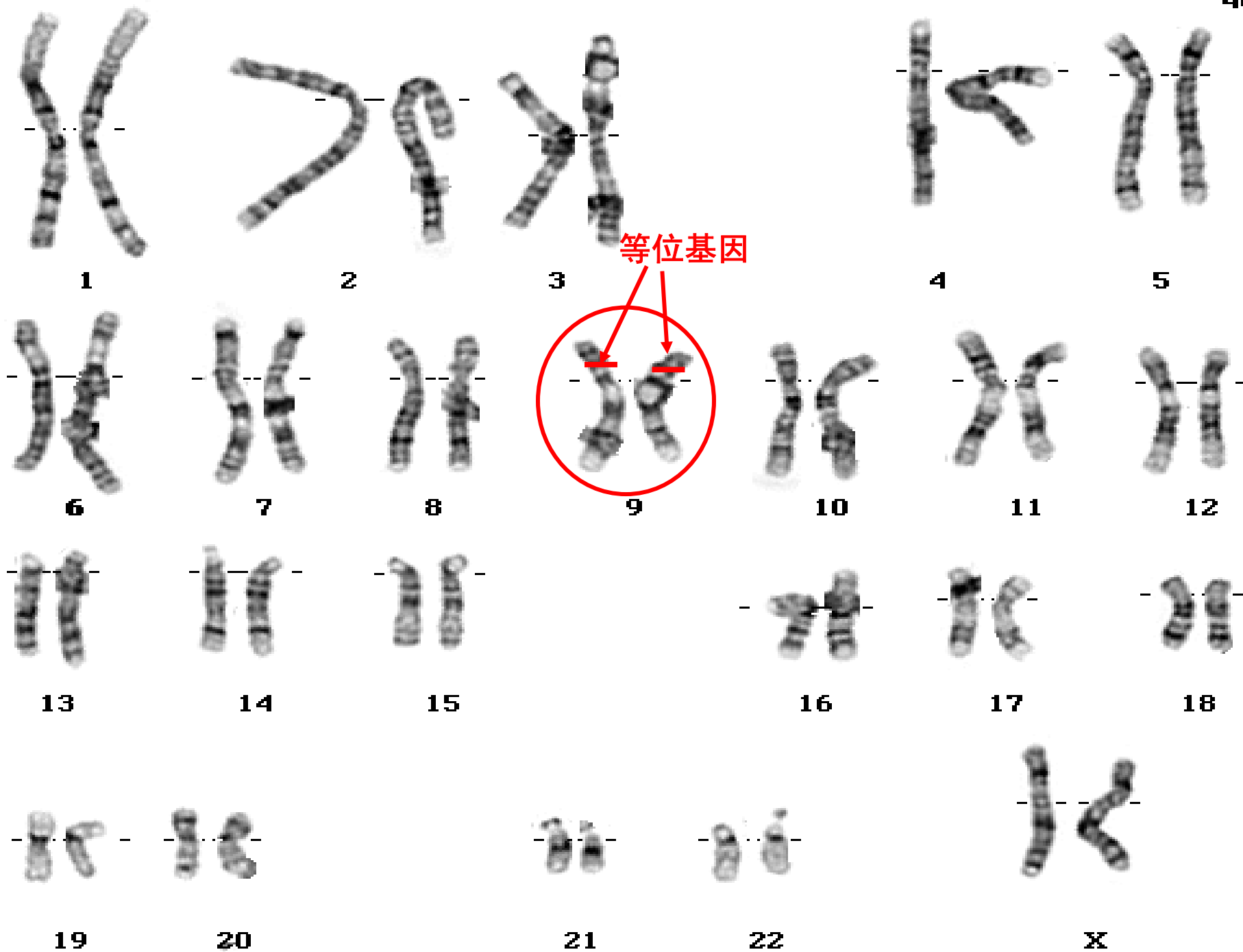

等位基因



个体1

个体2

个体3

个体4

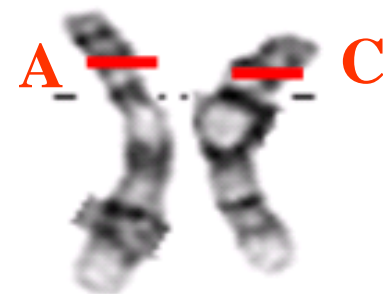
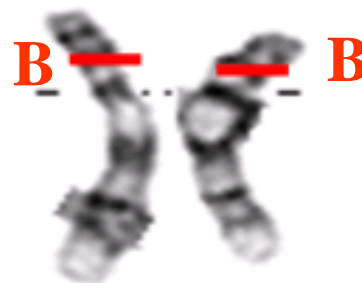
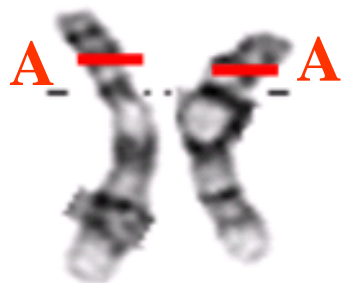

电泳



基因型

AA

AB

BB

AC

减数分裂

自由组合

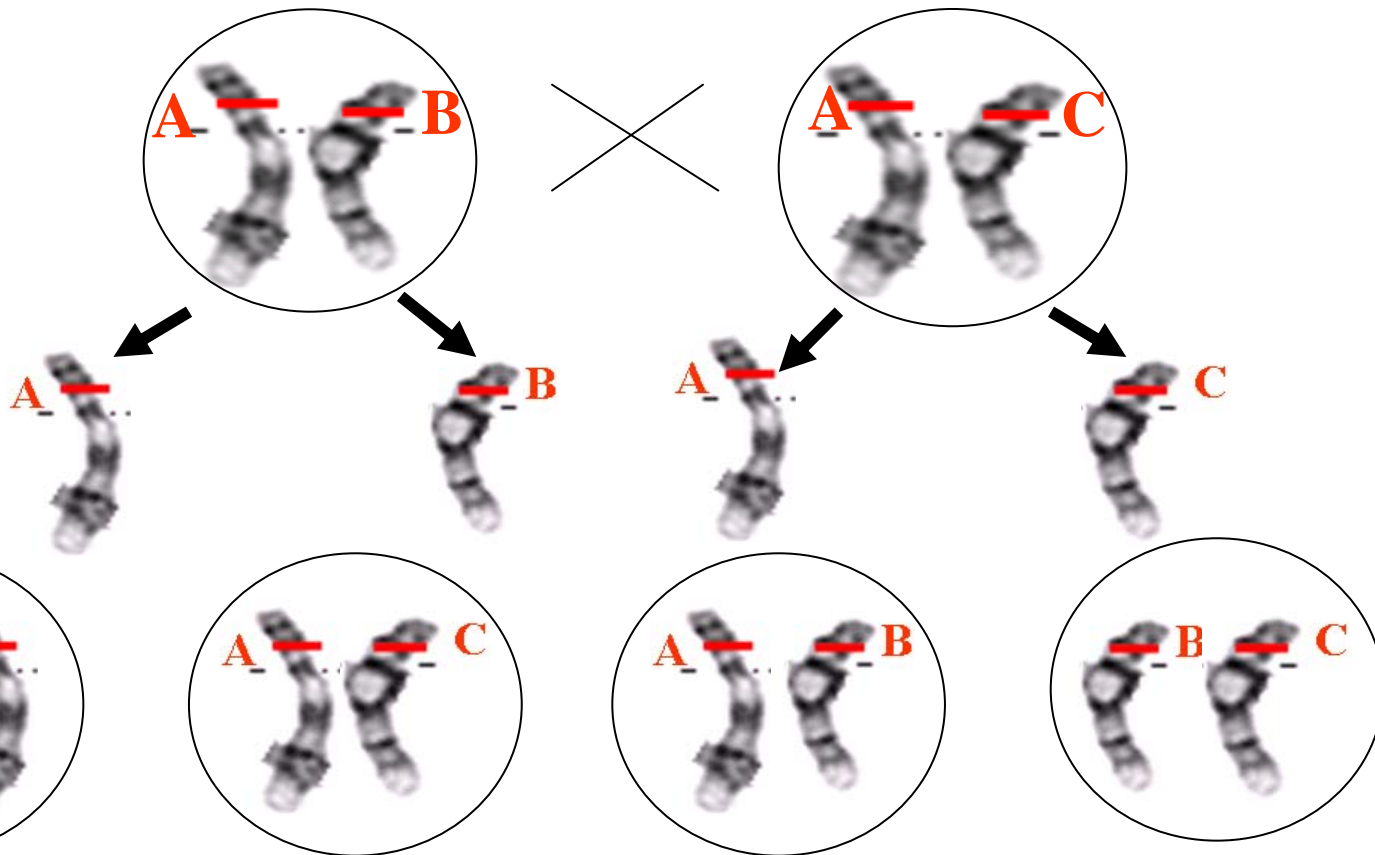

电泳

— A

— C

— A

— A

— C

— B

— B

基因型

AA

AC

AB

AB

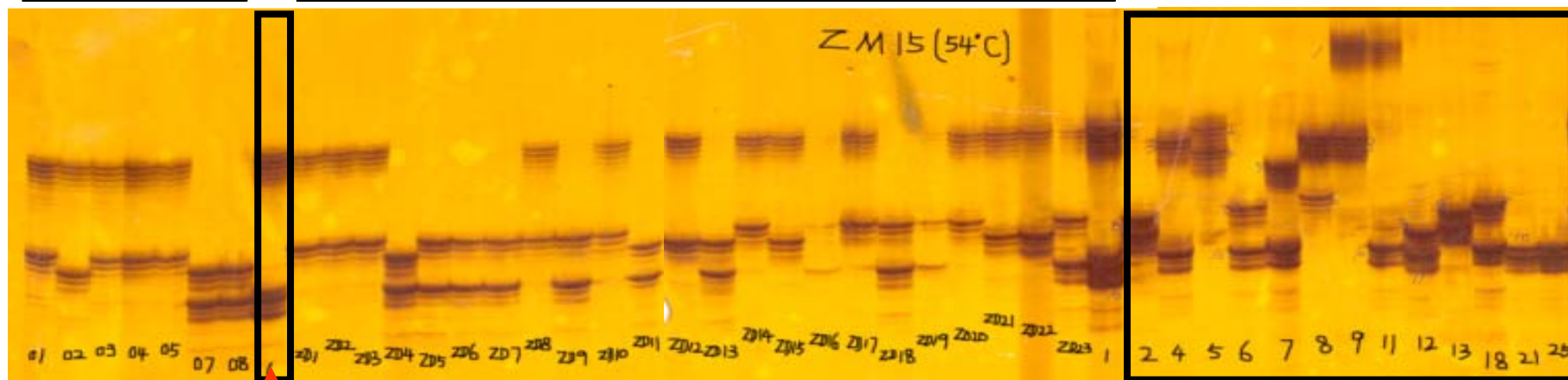
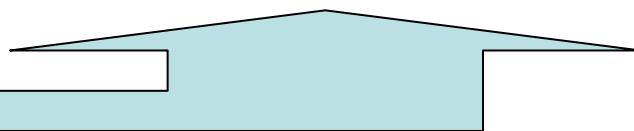
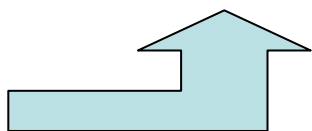

母本

海南苏铁
(*Cycas hainanensis*)

父本

二、分子遗传标记和种群空间格局

利用分子遗传标记我们可以知道不同亲缘关系个体在空间上的分布样式

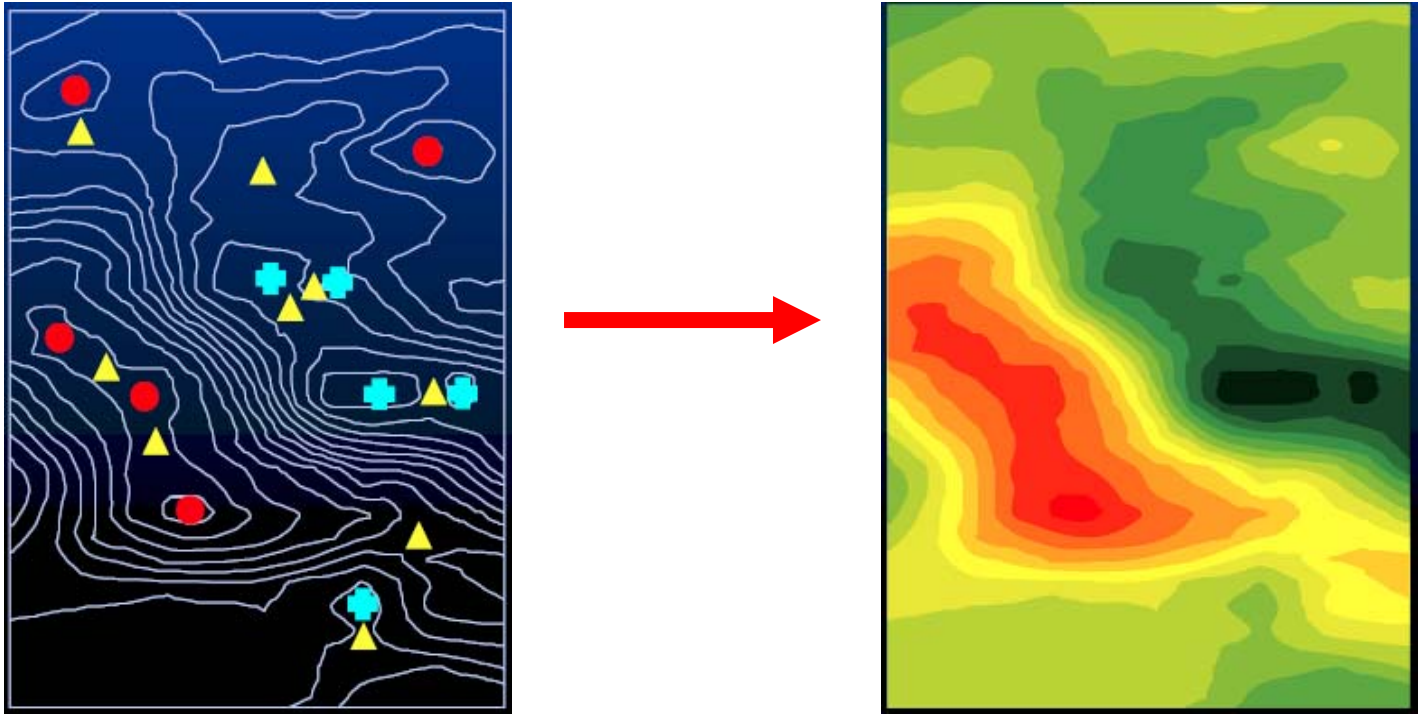

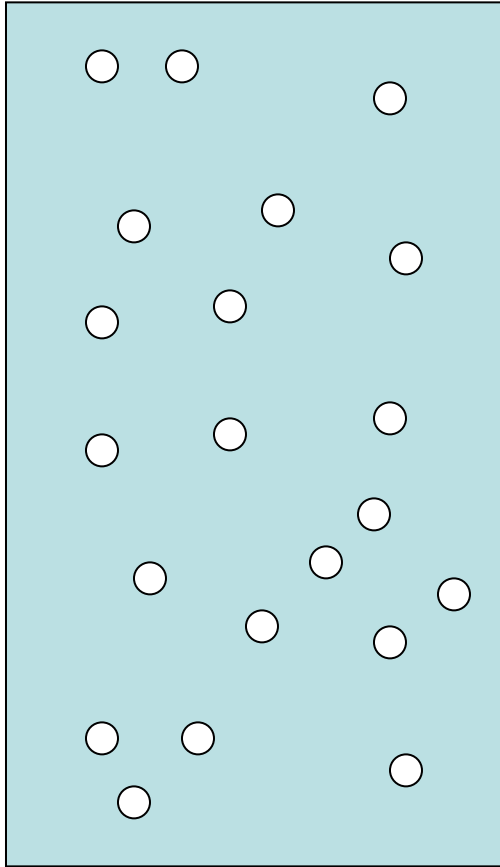

随机分布

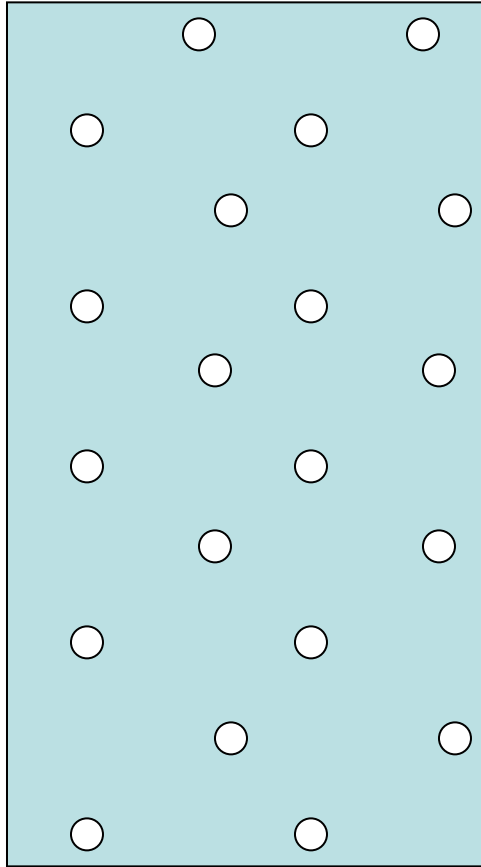

均匀分布

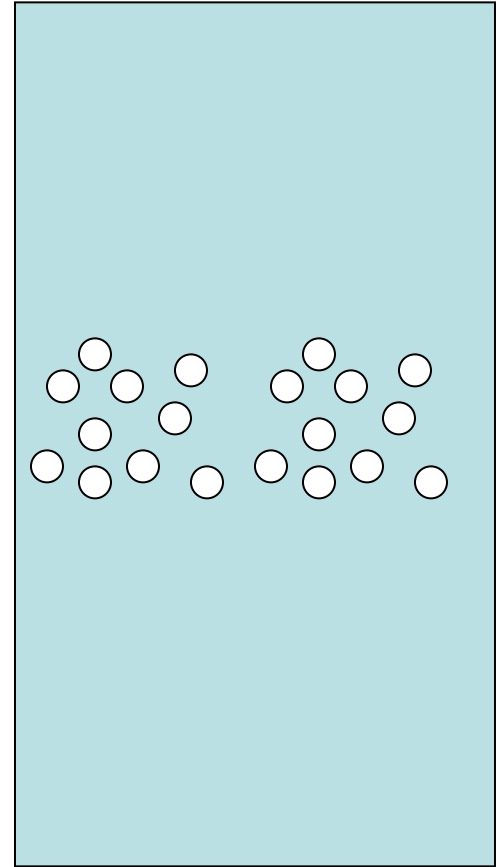

聚集分布

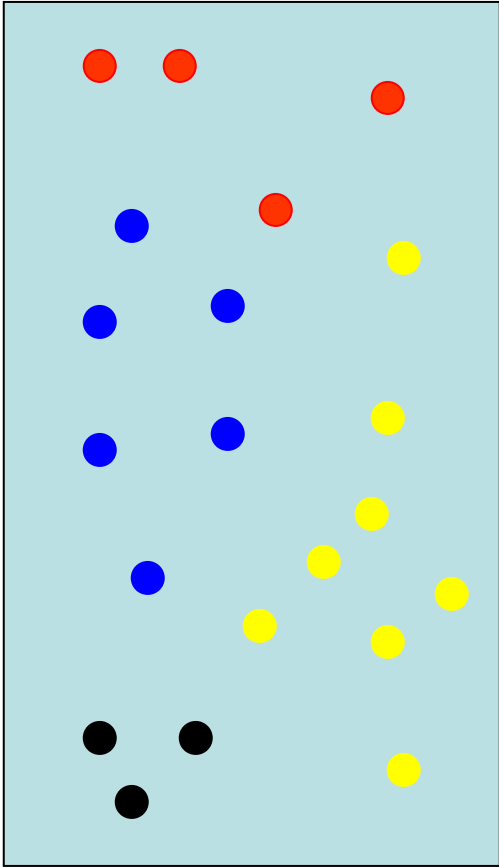

随机分布？

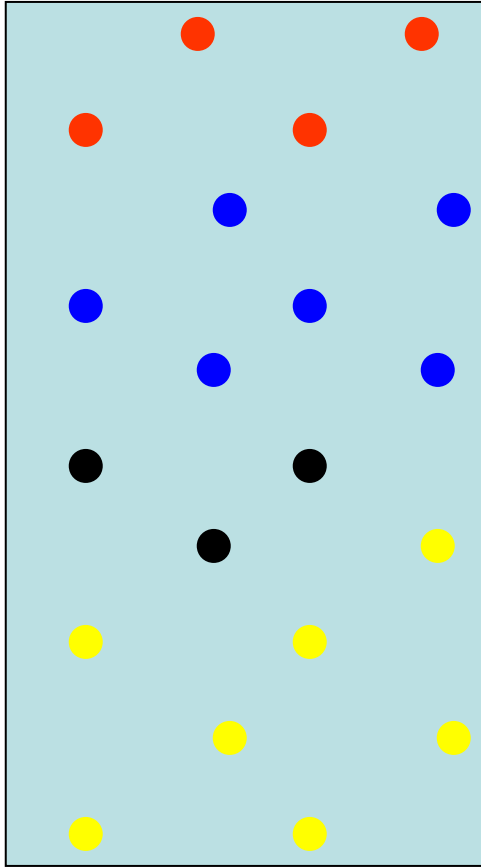

均匀分布？

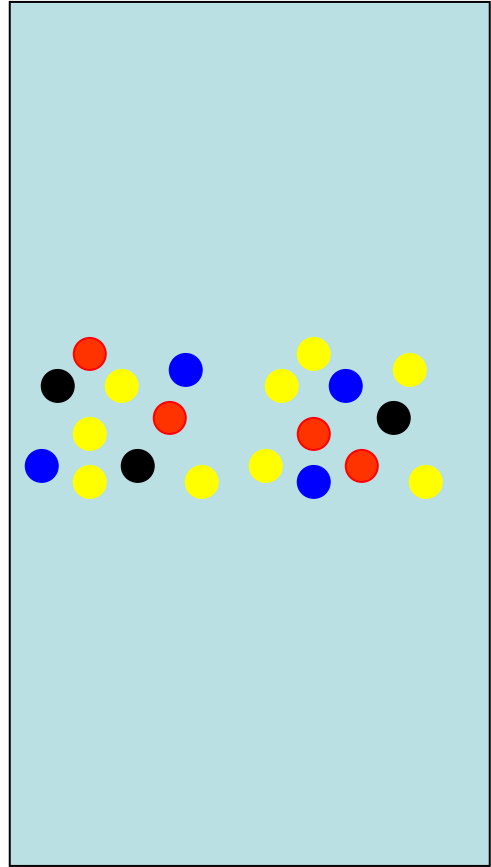

聚集分布？

基因型 ● AA ● AC ● AB ● BB

空间自相关分析 (spatial autocorrelation analysis)

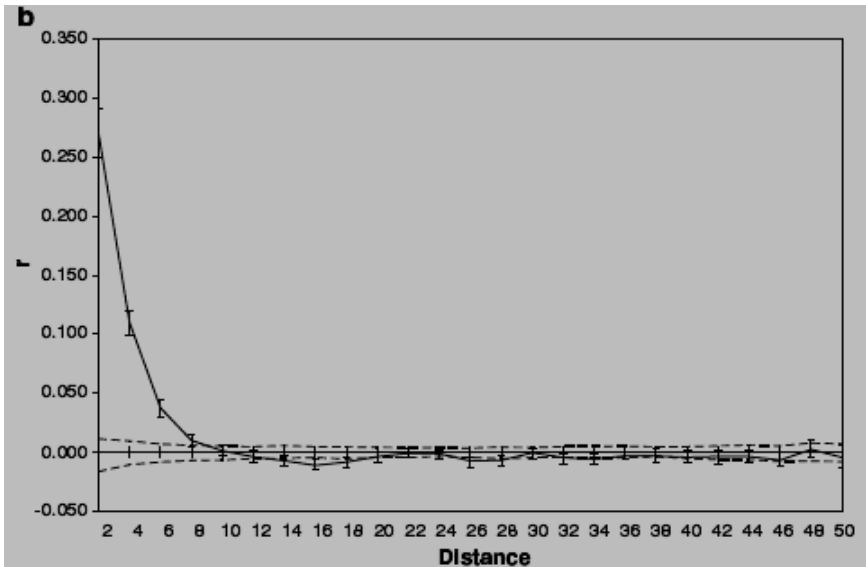
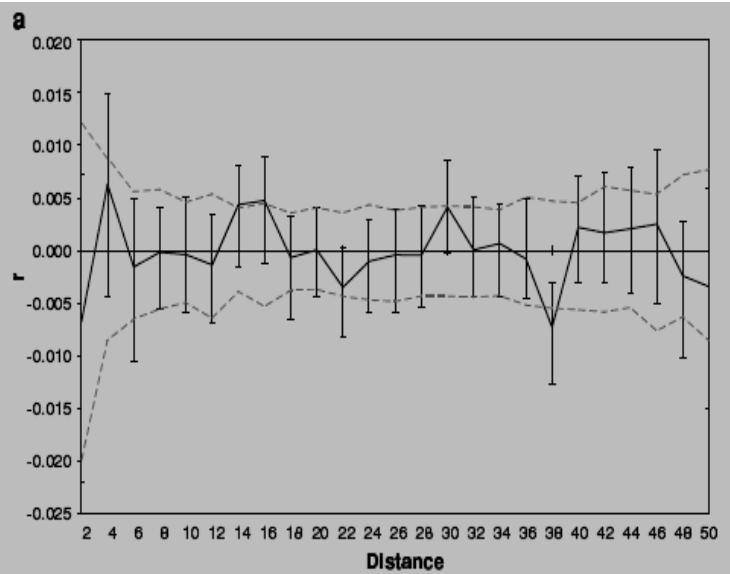
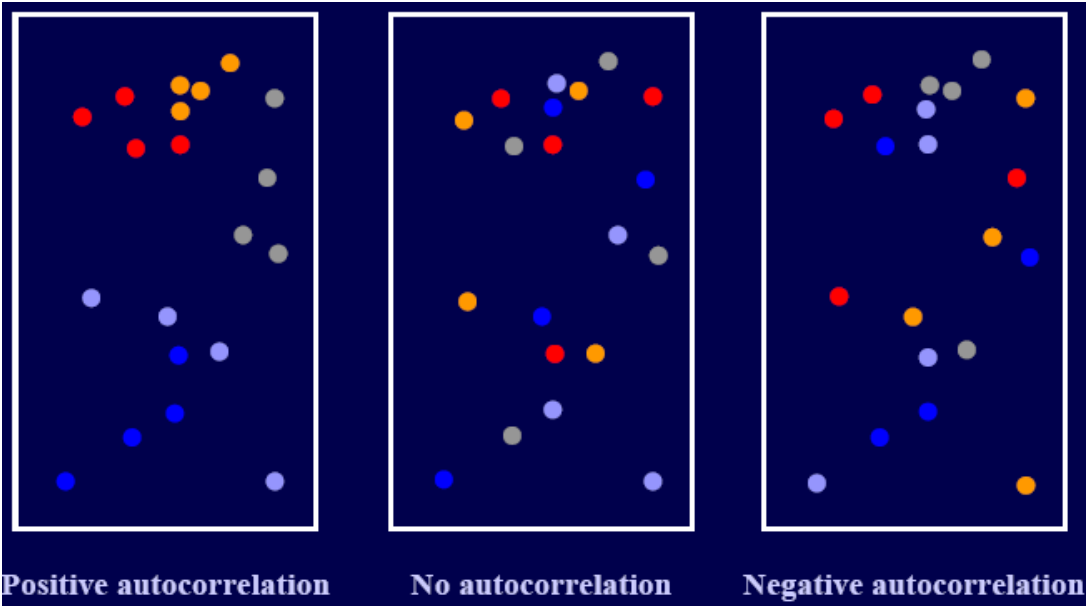

三、具体应用（空间遗传结构、花粉流、种子流）

空间遗传结构

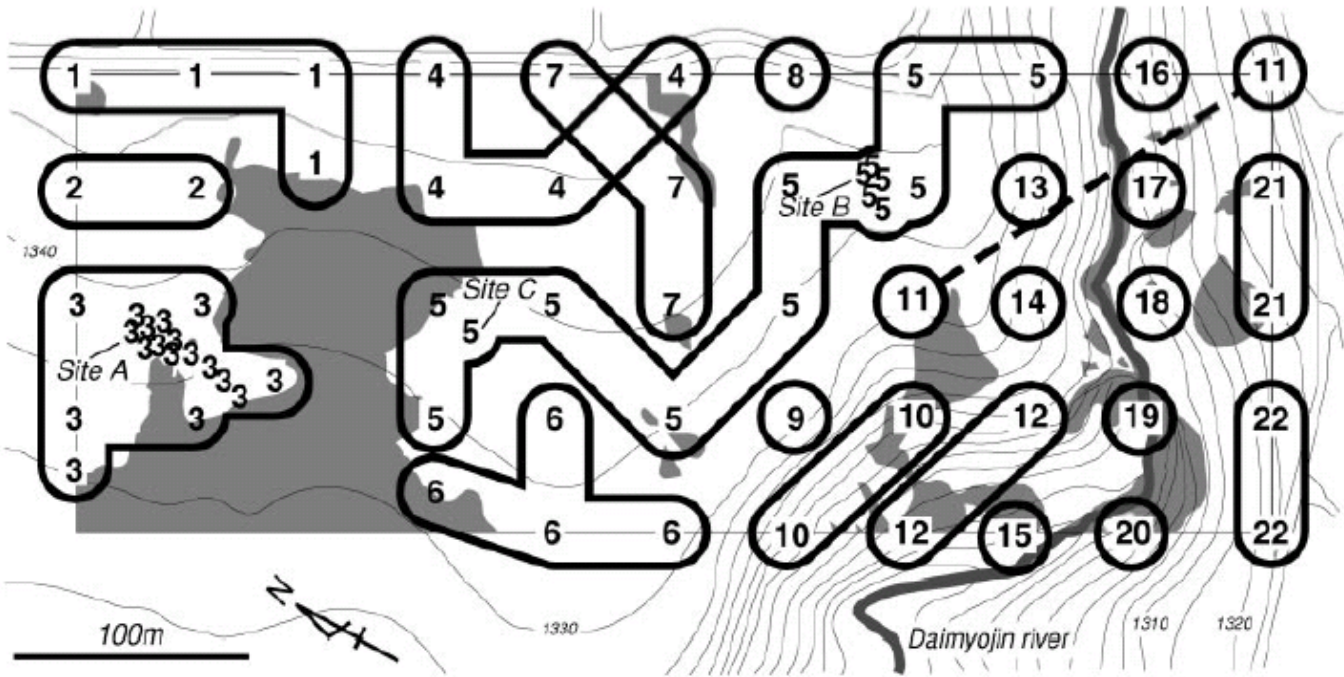

例子一

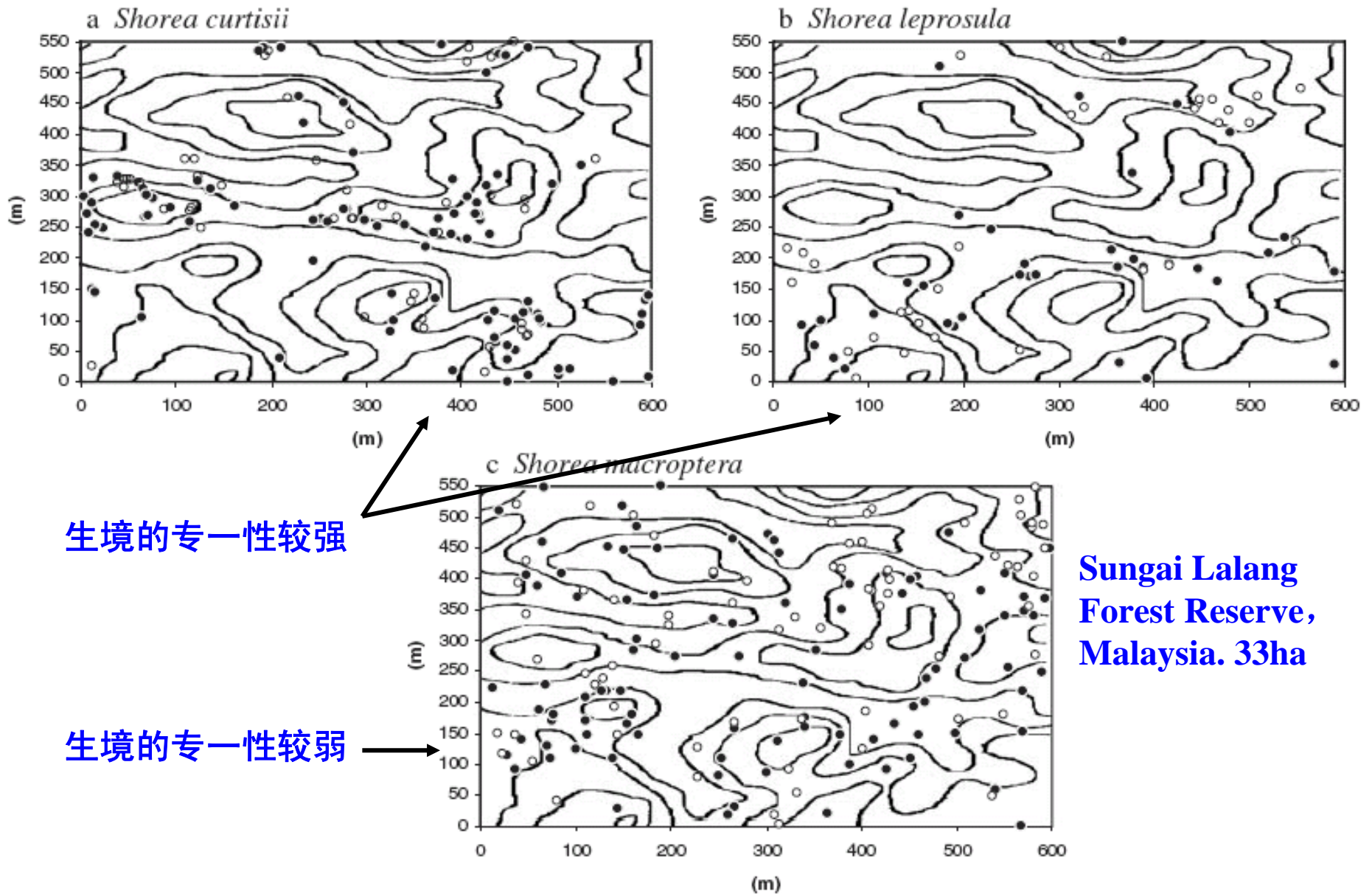

Ng K K S, Lee S L, Saw L G, Plotkin J B, Koh C L (2006) Spatial structure and genetic diversity of three tropical species with different habitat preferences within a natural forest. *Tree Genetics & Genomes*, 2: 121-131

分布格局分析

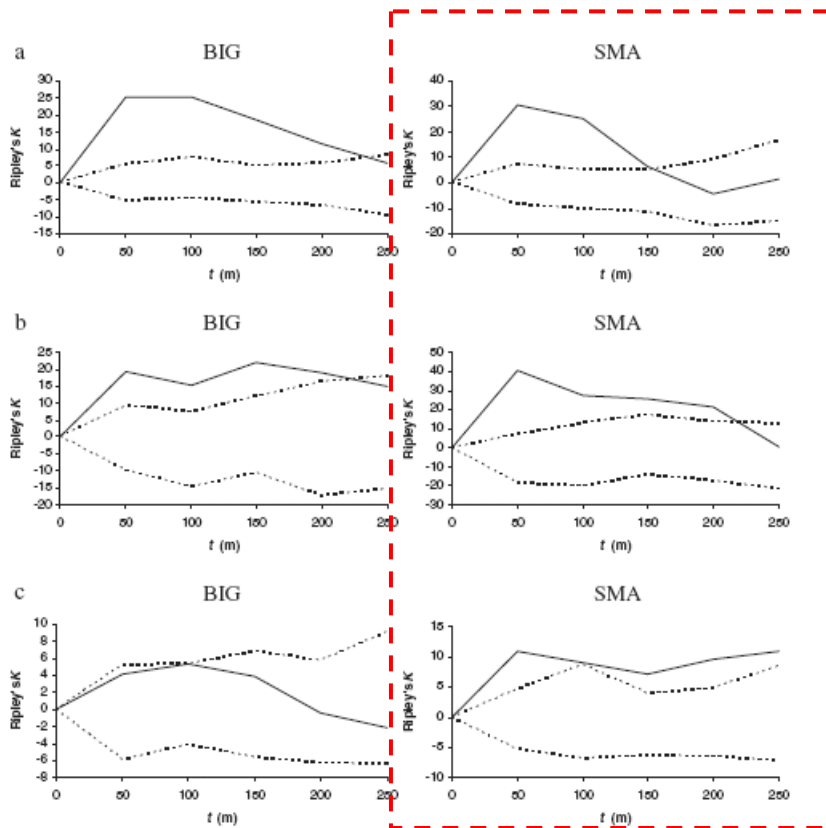

聚集分布

空间自相关分析

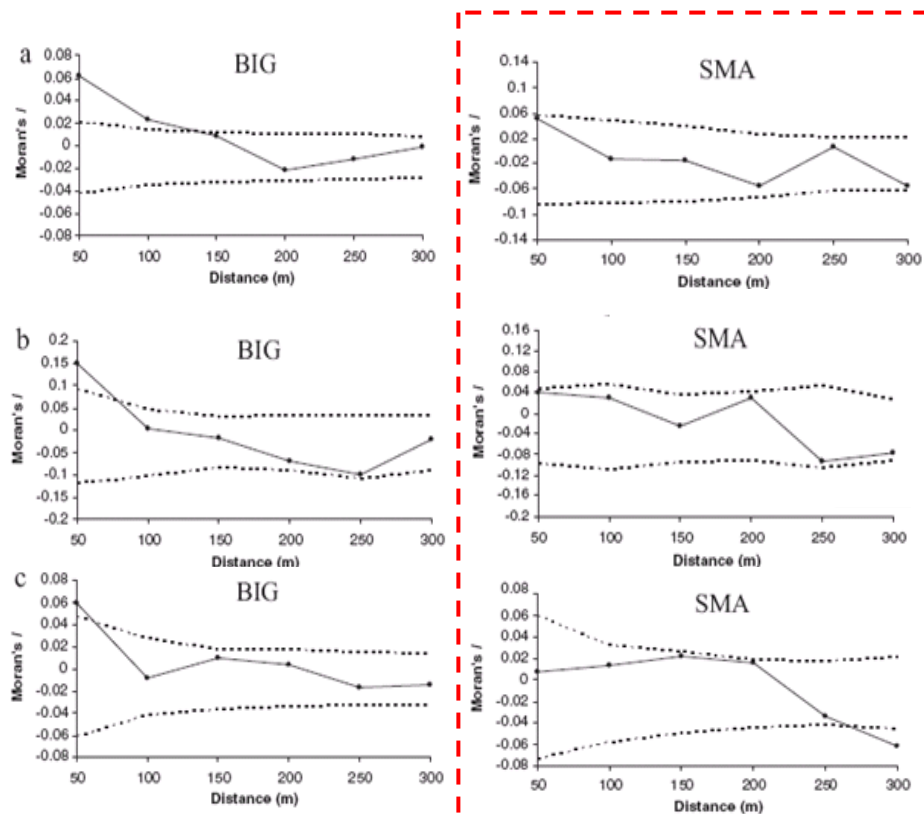

不相关分布

例子二



蓝桉 (*Eucalyptus globules*)

风向

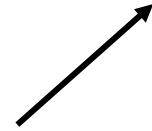

(a) Mature cohort

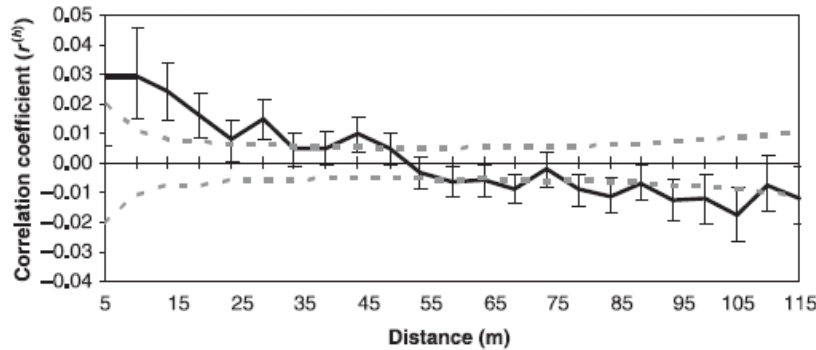

(b) Juvenile cohort

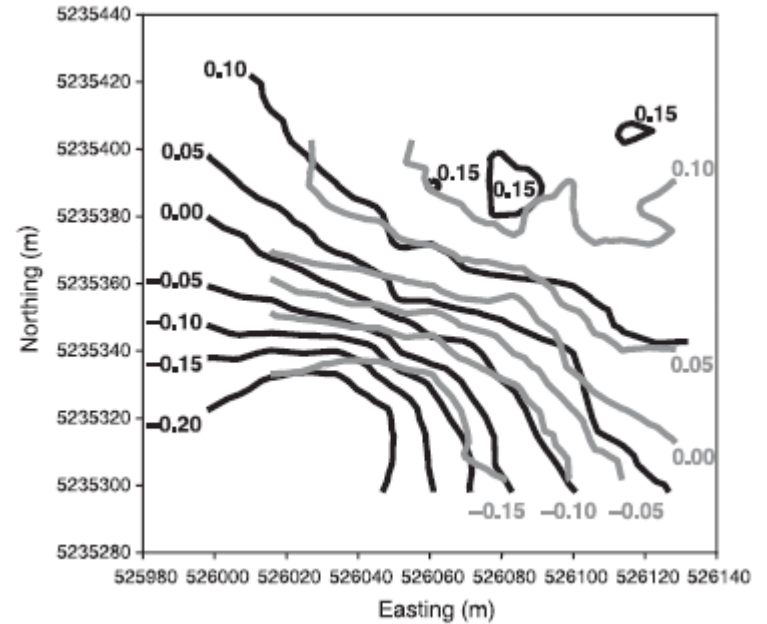
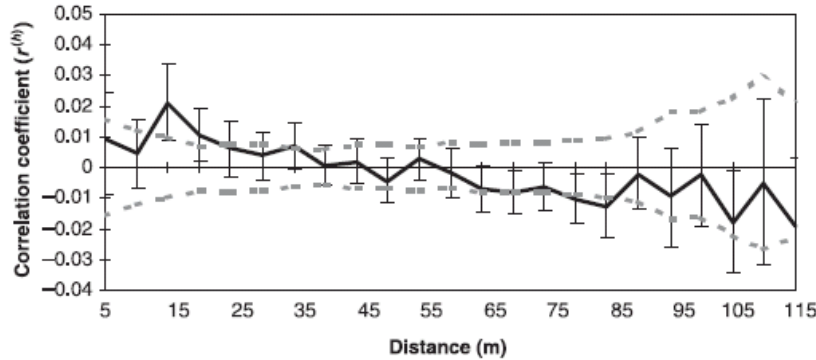

等值线图

Jones TH, Vaillancourt RE, Potts BM (2007) Detection and visualization of spatial genetic structure in continuous *Eucalyptus globules* forest. *Molecular Ecology*, 16: 697-707

花粉流

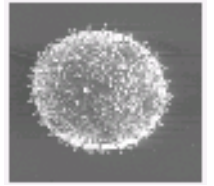
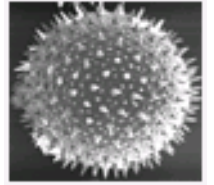
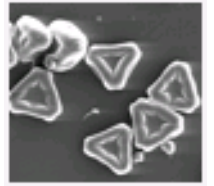
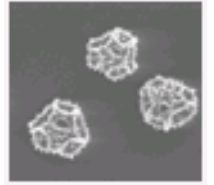
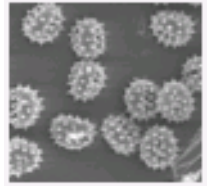
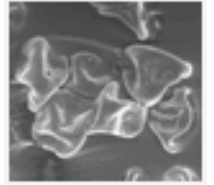

研究方法

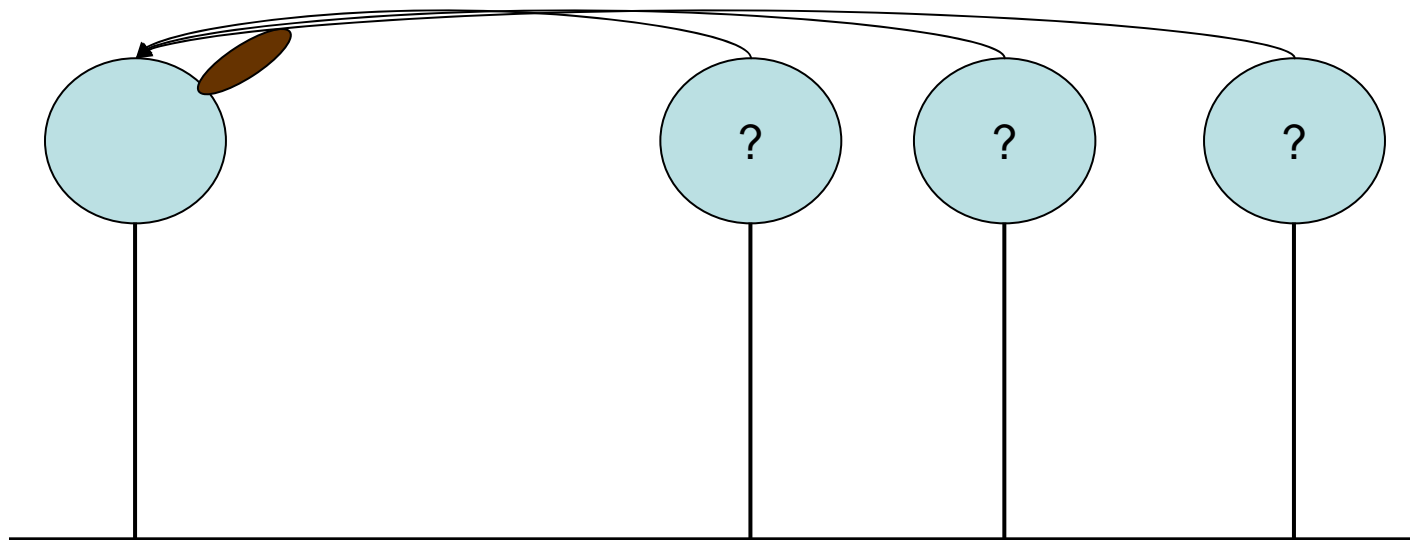

采集种子，母本清楚

种子所对应的可能父本

例子一

Dipterocarpus tempehes 龙脑香属

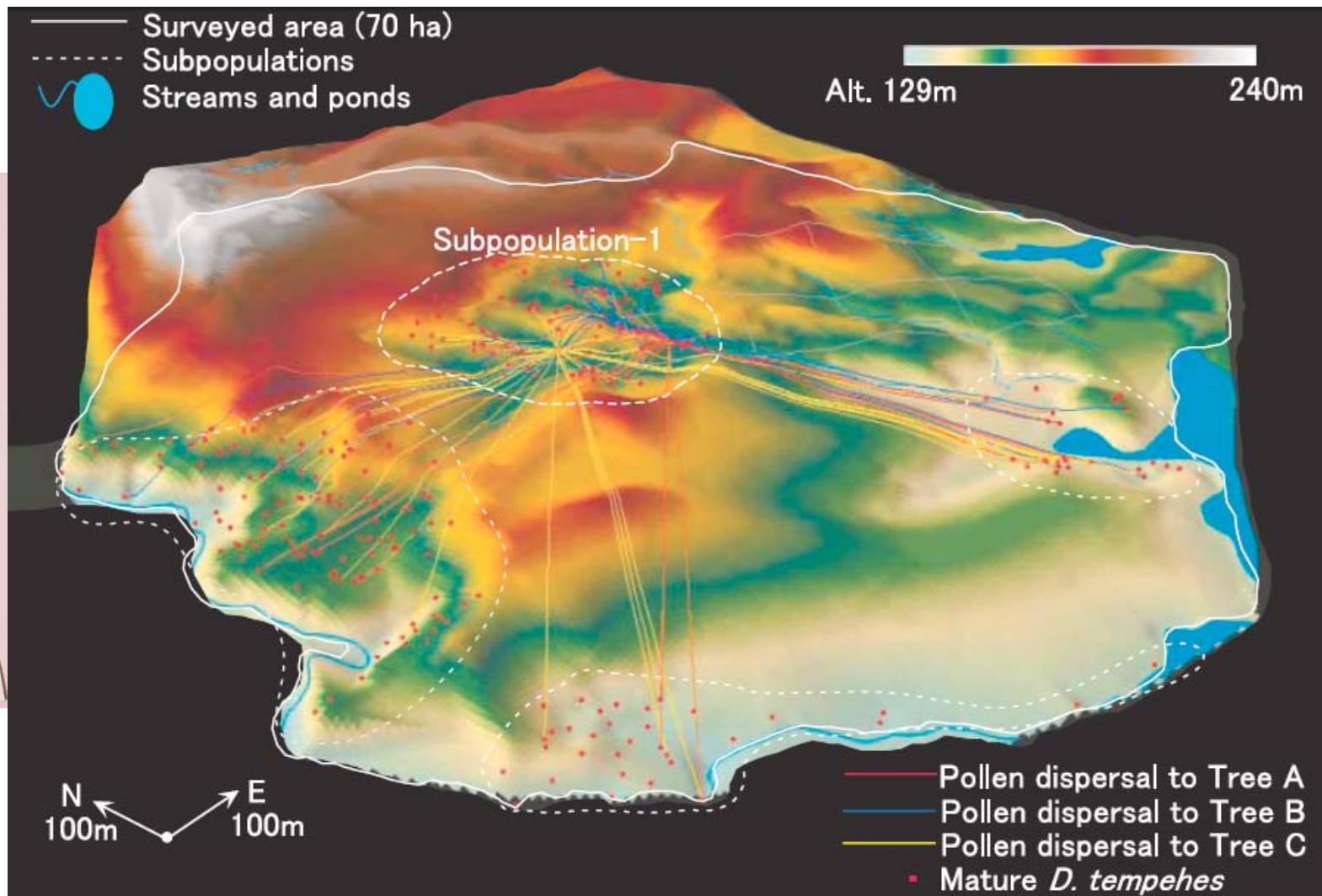

Kenta T, Isagi Y, Nakagawa M, Yamashita M, Nakashizuka T(2004) **Variation in pollen dispersal between years with different pollination conditions in a tropical emergent tree.** *Molecular Ecology*, 13: 3575–3584

例子二



欧洲赤松 (*Pinus sylvestris*)

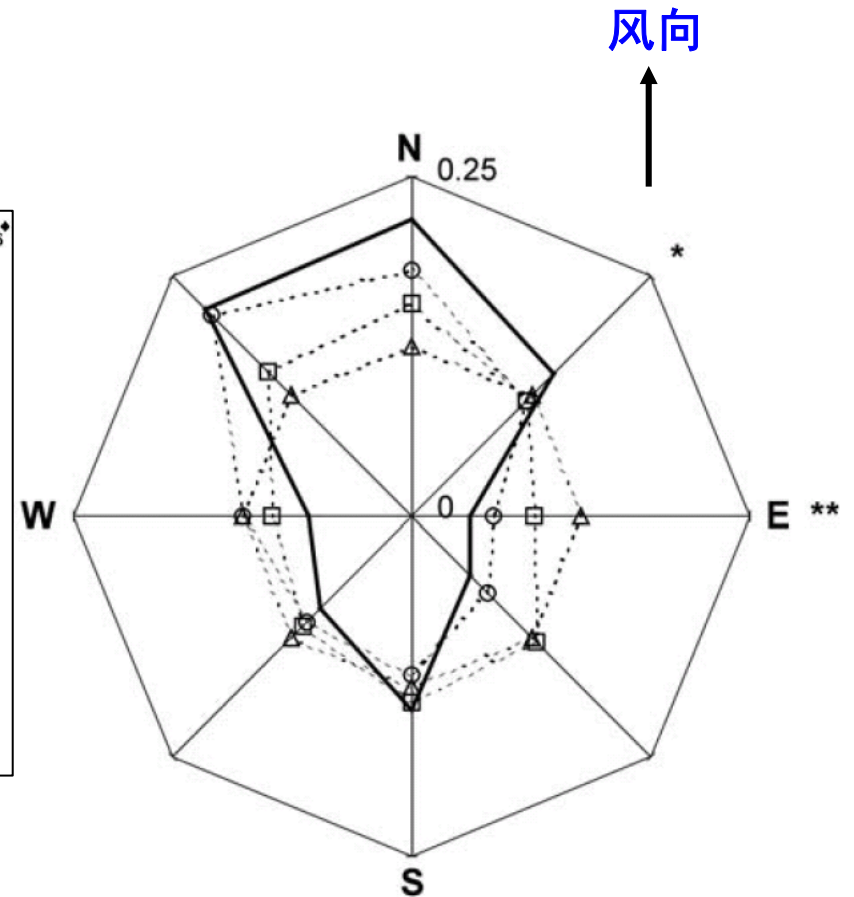
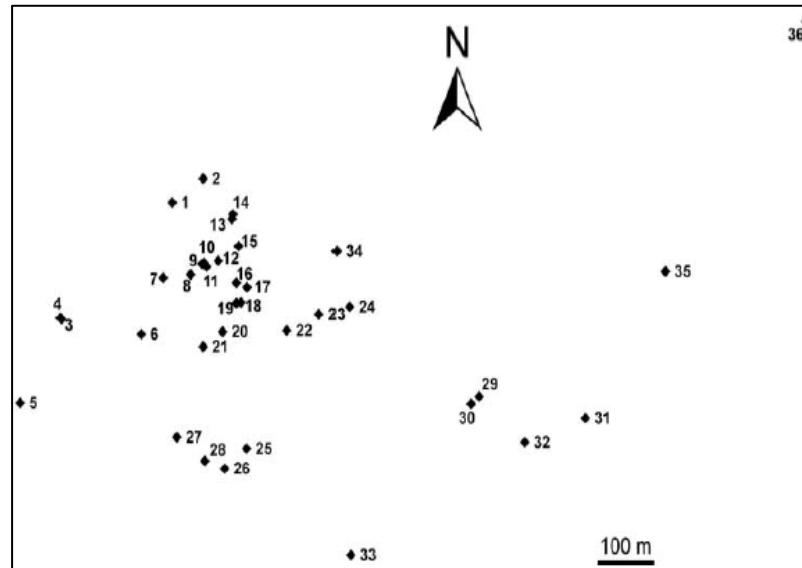

Robledo-Arnuncio JJ, Gil L (2005) Patterns of pollen dispersal in a small population of *Pinus sylvestris* L. revealed by total-exclusion paternity analysis. *Heredity*, 94: 13-22

种子流



例子一

蓝花楹 (*Jacaranda copaia*)

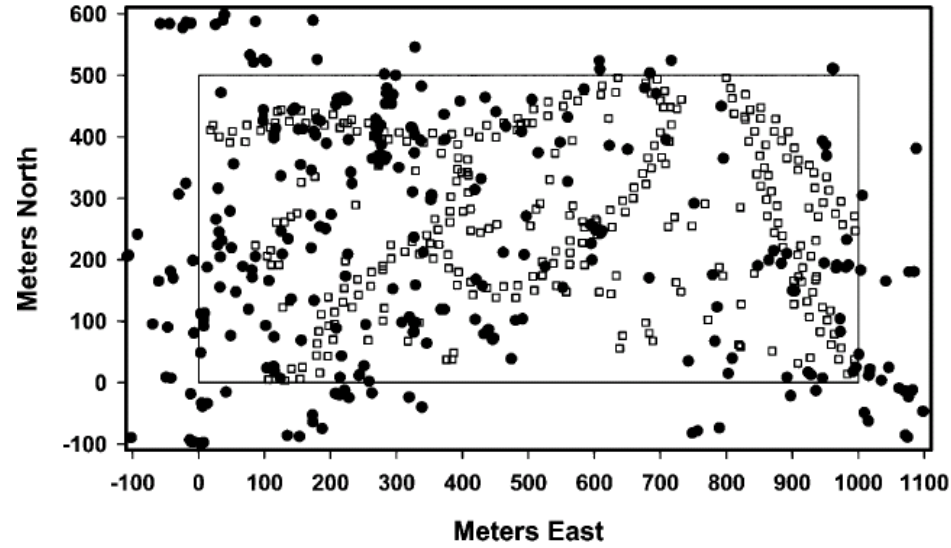
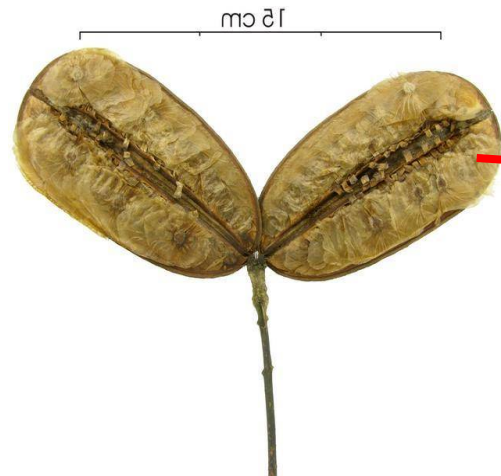

巴拿马Barro Colorado Island (BCI) 森林50公顷样地。探讨林窗与种子传播扩散的关系。利用种子的翅提取DNA。

Jones F A, Chen J, Weng G -J, Hubbell S P (2005) A genetic evaluation of seed dispersal in the Neotropical tree *Jacaranda copaia* (Bignoniaceae). The American naturalist, 166: 543-555

15 cm



例子二



櫻桃 (*Prunus mahaleb*)

- Endocarp 内果皮
- Testa 种皮
- Endosperm 胚乳
- Embryo 胚芽

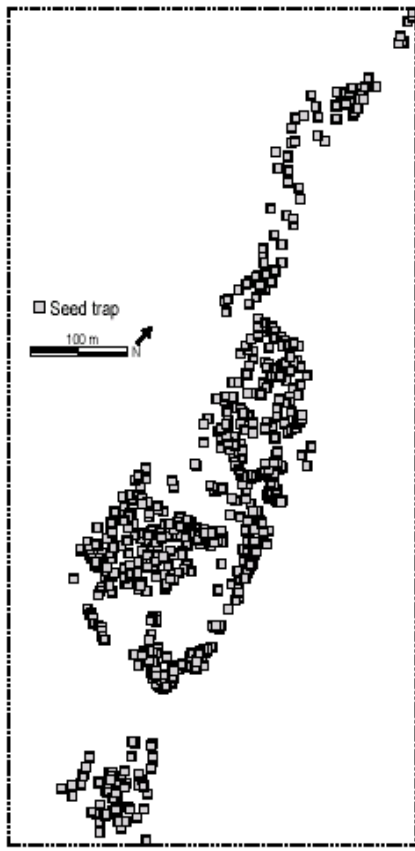
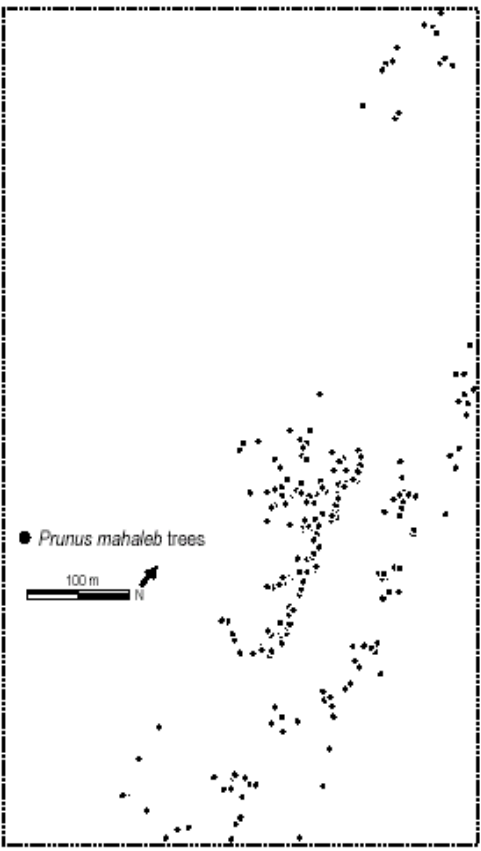
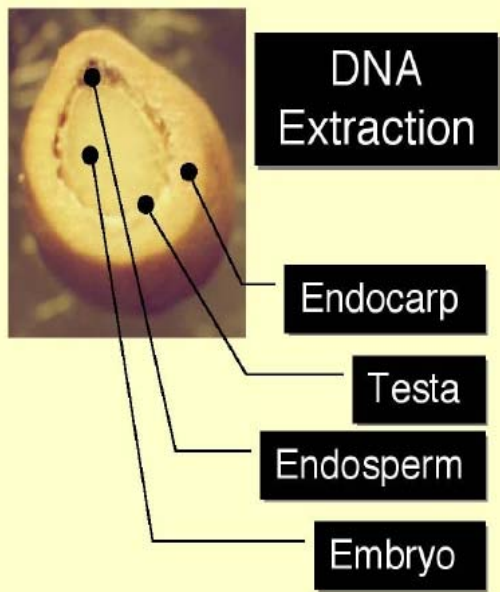

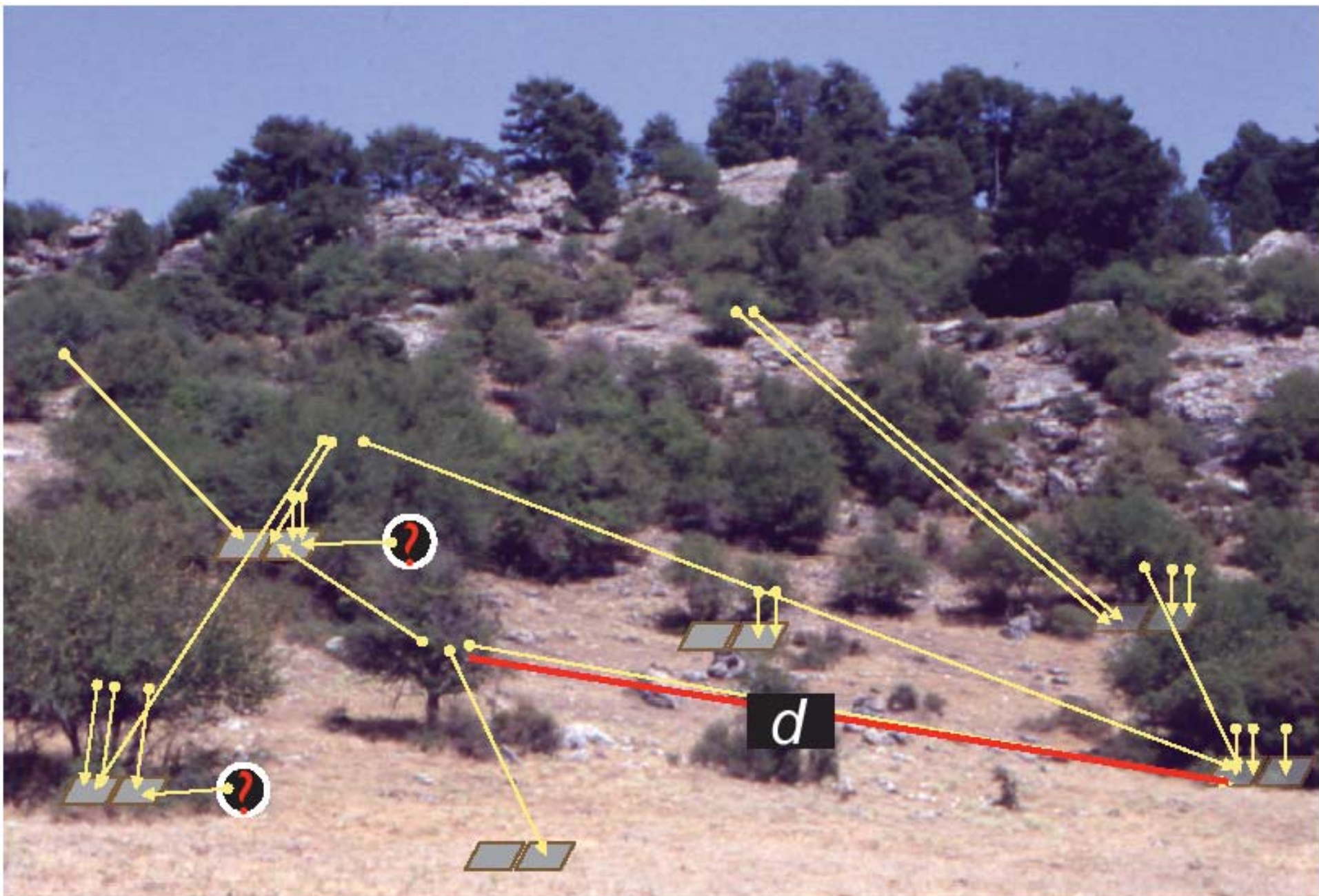

中型鸟:



Corvus corone



Turdus viscivorus

小型鸟:



phoenicurus ochruros



turdus merula



Erithacus rubecula



sylvia communis

大型哺乳动物:



狐狸



豹



獾

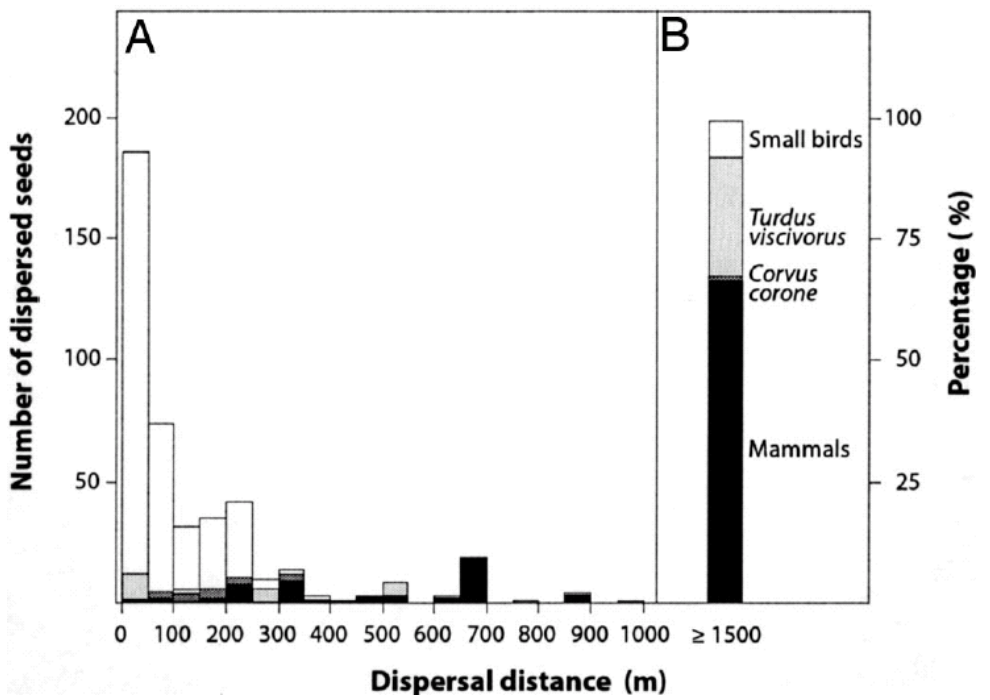

Vector	Sampling		Source tree location		Deposition per microhabitat, % (P_i^{out} , %)					
	N_i	Sampling points, no.	N_i^{in}	N_i^{put}	<i>P. mahaleb</i>	High shrub	Low shrub	<i>Pinus</i>	<i>Acer-Quercus</i>	Open
Small-birds	292	143	234	58	23 (17.0)	42 (20.0)	5 (7.2)	14 (18.6)	8 (10)	8 (7.2)
<i>T. viscivorus</i>	173	38	137	36	18 (19.4)	2 (33.0)	—	66 (21.5)	7 (16.7)	7 (16.7)
<i>C. corone</i>	23	4	10	13	—	—	—	—	—	100 (56.5)
Mammals	167	20	43	124	24 (79.4)	—	—	—	—	76 (67.2)

Godoy J A & Jordano P (2001) **Seed dispersal by animals: exact identification of source trees with endocarp DNA microsatellites.** *Molecular Ecology*, 2001, 10: 2275-2283

Jordano P, Garci C, Godoy J A, García-Castaño J L (2007) **Differential contribution of frugivores to complex seed dispersal patterns.** *PNAS*, 104 (9) : 3278 –3282

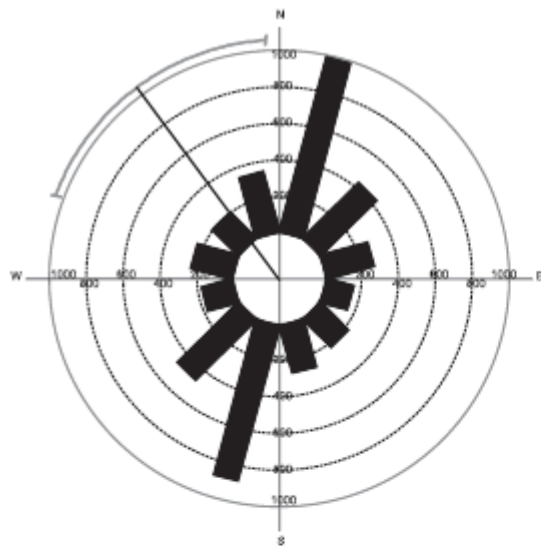

c. Potential seed dispersal (PS)

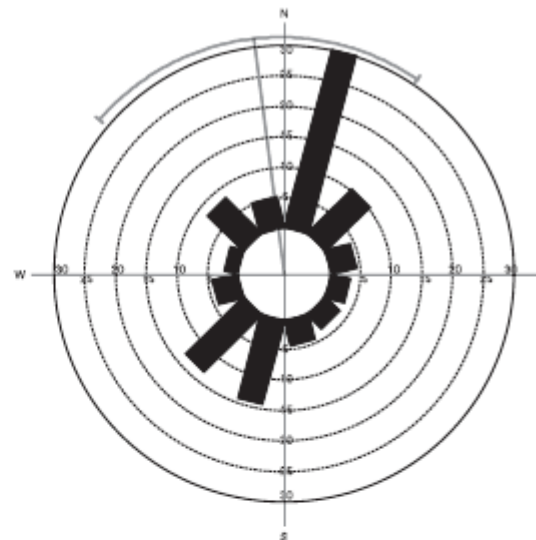

d. Actual seed dispersal (AS)

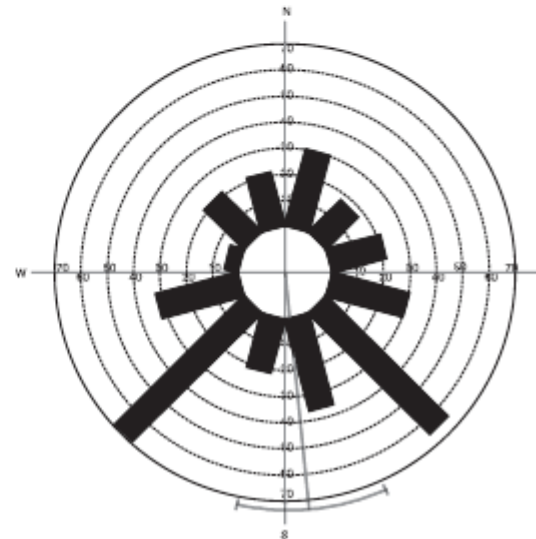
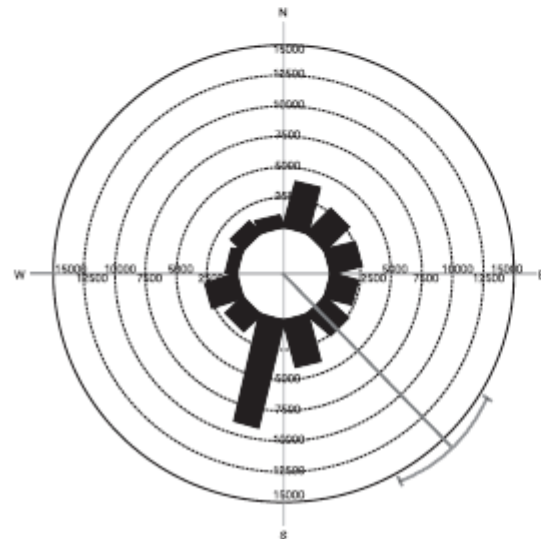

García C, Jordano P, Godoy J A (2007) Contemporary pollen and seed dispersal in a *Prunus mahaleb* population: patterns in distance and direction. *Molecular Ecology*, 16: 1947–1955

García C, Arroyo J M, Godoy J A, Jordano P (2005) Mating patterns, pollen dispersal, and the ecological maternal neighbourhood in a *Prunus mahaleb* L. population. Molecular Ecology, 14: 1821–1830

Robledo-Arnuncio J J, García C (2007) Estimation of the seed dispersal kernel from exact identification of source plants. Molecular Ecology, 16: 5098–5109

Fortuna M A, García C, Guimarães P R Jr, Bascompte J (2008) Spatial mating networks in insect-pollinated plants. Ecology Letter, 11(5): 490-498

四、鼎湖山大样地开展的研究

已经完成了大样地中三个物种：

锥栗、格木、厚壳桂、（黄果厚壳桂）的微卫星体标记筛选工作



厚壳桂

Conserv Genet (2007) 8:1235–1237
DOI 10.1007/s10592-006-9236-4

TECHNICAL NOTE

Isolation and characterization of microsatellite loci in *Cryptocarya chinensis* in lower subtropical China

Wang Zheng-Feng · Li Gang · Fu Sheng-Lei · Ren Hai

锥栗

Conserv Genet
DOI 10.1007/s10592-008-9690-2

TECHNICAL NOTE

Isolation and characterization of polymorphic microsatellite loci in *Castanopsis chinensis* Hance (Fagaceae)

Guomin Huang · Lan Hong · Wanhui Ye · Hao Shen · Honglin Cao · Wei Xiao

格木

Conserv Genet
DOI 10.1007/s10592-008-9676-0

TECHNICAL NOTE

Isolation and characterization of ten polymorphic microsatellite in the endangered tree *Erythrophleum fordii* Oliv

Peng Zhu · Wan-Hui Ye · Zheng-Feng Wang · Hong-Lin Cao · Min Zhang · Ling Li · Wei Xiao

五、展望

基因—性状—格局

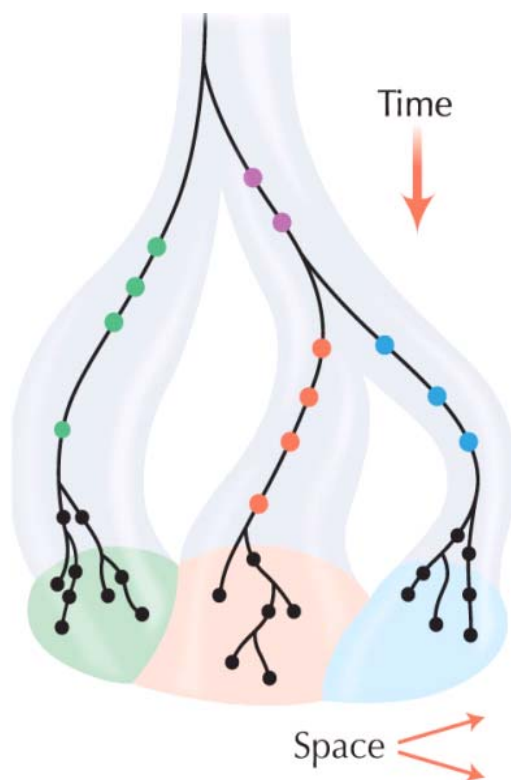

模型—数据处理

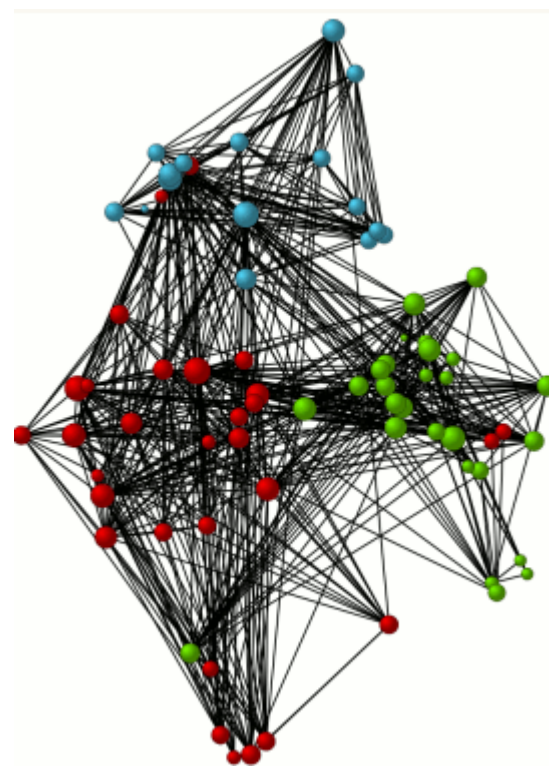



谢 谢